

HANGING BANNER 8FT CIRCLE 24IN



Product Features

The Skybox Fabric Hanging Banner is a must have at your next trade show. These extra large hanging banners are produced from high quality fabric and enable you to be seen from practically anywhere at your trade show. Available in round, square, and triangle configurations as well as numerous sizes, there is a Skybox Hanging Banner that would suit almost any situation. This particular model is 8ft wide and 2ft tall. Includes soft carry bag.

| | |
|--------------|---|
| Graphic Size | 301.59"W x 26"H (includes 2inches of bleed for height) |
| Display Size | 8' Diameter x 24"H |

Finishing

Hem with zipper

| | |
|-------------------|--------|
| Printing Material | Fabric |
|-------------------|--------|

Construction

All aluminum frame construction

Weights - Dimensions

| | |
|---------------------|----------------|
| Shipping Weight | 23 lbs |
| Shipping Dimensions | 72" x 17" x 9" |





Graphic Specification

301.59"W x 26"H (includes 2inches of bleed for height)

Graphic Turnaround Time

Standard : 5 business days

Parts List

| | |
|--|---|
|  |  |
| (10) Chain | (24) Spring |
|  | |
| (4) Curved Stabilizer | |
|  | |
| (8) Quarter Circle | |
|  | |
| (1) Nylon Travel Bag | |
|  |  |
| (8) Curved Connector | (4) Eye Hook |
|  |  |
| (4) Large Screw | (10) Hook Loop Lock |
|  |  |
| (1) Screw Tightener | (1) Cable - 10 M |

The box represents 16'x16' booth.

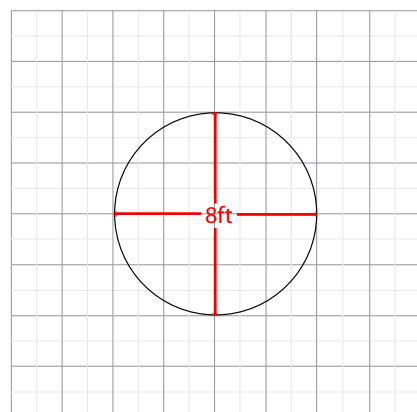

HANGING BANNER 8FT CIRCLE 32IN



Product Features

The Skybox Fabric Hanging Banner is a must have at your next trade show. These extra large hanging banners are produced from high quality fabric and enable you to be seen from practically anywhere at your trade show. Available in round, square, and triangle configurations as well as numerous sizes, there is a Skybox Hanging Banner that would suit almost any situation. This particular model is 8ft wide and 32 inches tall. Includes soft carry bag.

| | |
|--------------|---|
| Graphic Size | 301.59"W x 34"H (includes 2inches of bleed for height) |
|--------------|---|

| | |
|--------------|--------------------|
| Display Size | 8' Diameter x 32"H |
|--------------|--------------------|

Finishing

Hem with zipper

| | |
|-------------------|--------|
| Printing Material | Fabric |
|-------------------|--------|

Construction

All aluminum frame construction

Weights - Dimensions

| | |
|-----------------|--------|
| Shipping Weight | 25 lbs |
|-----------------|--------|

| | |
|---------------------|----------------|
| Shipping Dimensions | 72" x 17" x 9" |
|---------------------|----------------|

Graphic Specification

301.59"W x 34"H (includes 2inches of bleed for height)

Graphic Turnaround Time

Standard : 5 business days

Parts List



(10) Chain



(24) Spring



(4) Curved Stabilizer



(8) Quarter Circle



(1) Nylon Travel Bag



(8) Curved Connector



(4) Eye Hook



(4) Large Screw



(10) Hook Loop Lock



(1) Screw Tightener



(1) Cable - 10 M

The box represents 16'x16' booth.

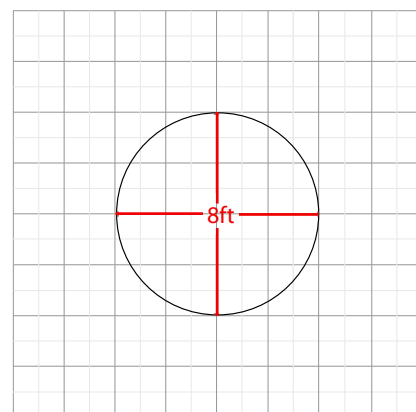

HANGING BANNER 8FT CIRCLE 36IN



Product Features

The Skybox Fabric Hanging Banner is a must have at your next trade show. These extra large hanging banners are produced from high quality fabric and enable you to be seen from practically anywhere at your trade show. Available in round, square, and triangle configurations as well as numerous sizes, there is a Skybox Hanging Banner that would suit almost any situation. This particular model is 8ft wide and 32 inches tall. Includes soft carry bag.

| | |
|--------------|---|
| Graphic Size | 301.59"W x 38"H (includes 2inches of bleed for height) |
| Display Size | 8' Diameter x 36"H |

Finishing

Hem with zipper

| | |
|-------------------|--------|
| Printing Material | Fabric |
|-------------------|--------|

Construction

All aluminum frame construction

Weights - Dimensions

| | |
|---------------------|----------------|
| Shipping Weight | 27 lbs |
| Shipping Dimensions | 72" x 17" x 9" |









Graphic Specification

301.59"W x 36"H (includes 2inches of bleed for height)

Graphic Turnaround Time

Standard : 5 business days

Parts List

| | |
|--|---|
|  |  |
| (10) Chain | (24) Spring |
|  | |
| (4) Curved Stabilizer | |
|  | |
| (8) Quarter Circle | |
|  | |
| (1) Nylon Travel Bag | |
|  |  |
| (8) Curved Connector | (4) Eye Hook |
|  |  |
| (4) Large Screw | (10) Hook Loop Lock |
|  |  |
| (1) Screw Tightener | (1) Cable - 10 M |

The box represents 16'x16' booth.

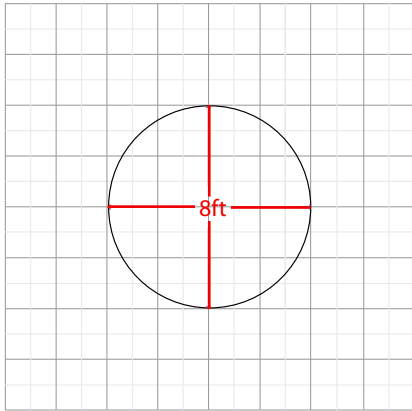

HANGING BANNER 8FT CIRCLE 42IN



Product Features

The Skybox Fabric Hanging Banner is a must have at your next trade show. These extra large hanging banners are produced from high quality fabric and enable you to be seen from practically anywhere at your trade show. Available in round, square, and triangle configurations as well as numerous sizes, there is a Skybox Hanging Banner that would suit almost any situation. This particular model is 8ft wide and 42 inches tall. Includes soft carry bag.

| | |
|--------------|---|
| Graphic Size | 301.59"W x 44"H (includes 2inches of bleed for height) |
|--------------|---|

| | |
|--------------|--------------------|
| Display Size | 8' Diameter x 42"H |
|--------------|--------------------|

Finishing

Hem with zipper

| | |
|-------------------|--------|
| Printing Material | Fabric |
|-------------------|--------|

Construction

All aluminum frame construction

Weights - Dimensions

| | |
|-----------------|--------|
| Shipping Weight | 29 lbs |
|-----------------|--------|

| | |
|---------------------|----------------|
| Shipping Dimensions | 72" x 17" x 9" |
|---------------------|----------------|

Graphic Specification

301.59"W x 44"H (includes 2inches of bleed for height)

Graphic Turnaround Time

Standard : 5 business days

Parts List

| | |
|--|---|
|  |  |
| (10) Chain | (24) Spring |
|  | |
| (4) Curved Stabilizer | |
|  | |
| (8) Quarter Circle | |
|  | |
| (1) Nylon Travel Bag | |
|  |  |
| (8) Curved Connector | (4) Eye Hook |
|  |  |
| (4) Large Screw | (10) Hook Loop Lock |
|  |  |
| (1) Screw Tightener | (1) Cable - 10 M |

The box represents 16'x16' booth.

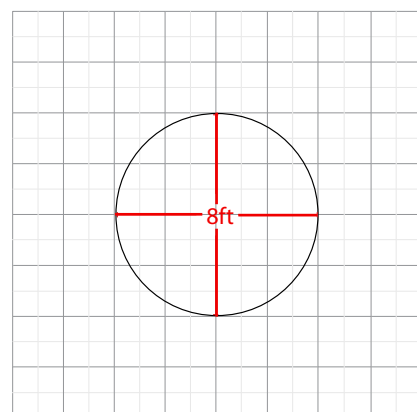

HANGING BANNER 8FT CIRCLE 48IN



Product Features

The Skybox Fabric Hanging Banner is a must have at your next trade show. These extra large hanging banners are produced from high quality fabric and enable you to be seen from practically anywhere at your trade show. Available in round, square, and triangle configurations as well as numerous sizes, there is a Skybox Hanging Banner that would suit almost any situation. This particular model is 8ft wide and 4ft tall. Includes soft carry bag.

| | |
|--------------|---|
| Graphic Size | 301.59"W x 50"H (includes 2inches of bleed for height) |
| Display Size | 8' Diameter x 48"H |

Finishing

Hem with zipper

| | |
|-------------------|--------|
| Printing Material | Fabric |
|-------------------|--------|

Construction

All aluminum frame construction

Weights - Dimensions

| | |
|---------------------|----------------|
| Shipping Weight | 31lbs |
| Shipping Dimensions | 72" x 17" x 9" |





Graphic Specification

301.59"W x 50"H (includes 2inches of bleed for height)

Graphic Turnaround Time

Standard : 5 business days

Parts List

| | |
|--|---|
|  |  |
| (10) Chain | (24) Spring |
|  | |
| (4) Curved Stabilizer | |
|  | |
| (8) Quarter Circle | |
|  | |
| (1) Nylon Travel Bag | |
|  |  |
| (8) Curved Connector | (4) Eye Hook |
|  |  |
| (4) Large Screw | (10) Hook Loop Lock |
|  |  |
| (1) Screw Tightener | (1) Cable - 10M |

The box represents 16'x16' booth.

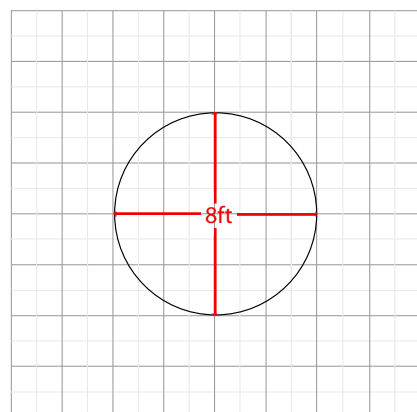

HANGING BANNER 10FT CIRCLE 24IN



Product Features

The Skybox Fabric Hanging Banner is a must have at your next trade show. These extra large hanging banners are produced from high quality fabric and enable you to be seen from practically anywhere at your trade show. Available in round, square, and triangle configurations as well as numerous sizes, there is a Skybox Hanging Banner that would suit almost any situation. This particular model is 10ft wide and 42 inches tall. Includes soft carry bag.

| | |
|--------------|--|
| Graphic Size | 376.991"W x 26"H (includes 2inches of bleed for height) |
| Display Size | 10' Diameter x 24"H |

Finishing

Hem with zipper

| | |
|-------------------|--------|
| Printing Material | Fabric |
|-------------------|--------|

Construction

All aluminum frame construction

Weights - Dimensions

| | |
|---------------------|--------------|
| Shipping Weight | 26 lbs |
| Shipping Dimensions | 61"x 15"x 9" |



Graphic Specification

376.991"W x 26"H (includes 2inches of bleed for height)

Graphic Turnaround Time

Standard : 5 business days

Parts List

| | |
|--|---|
|  |  |
| (8) Chain | (36) Spring |
|  | |
| (6) Curved Stabilizer | |
|  | |
| (12) Quarter Circle | |
|  | |
| (1) Nylon Travel Bag | |
|  |  |
| (12) Curved Connector | (3) Eye Hook |
|  |  |
| (9) Large Screw | (8) Hook Loop Lock |
|  |  |
| (1) Screw Tightener | (1) Cable - 9 M |

The box represents 16'x16' booth.

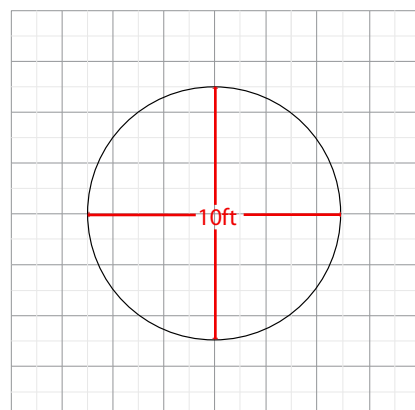

HANGING BANNER 10FT CIRCLE 32IN



Product Features

The Skybox Fabric Hanging Banner is a must have at your next trade show. These extra large hanging banners are produced from high quality fabric and enable you to be seen from practically anywhere at your trade show. Available in round, square, and triangle configurations as well as numerous sizes, there is a Skybox Hanging Banner that would suit almost any situation. This particular model is 10ft wide and 42 inches tall. Includes soft carry bag.

| | |
|--------------|--|
| Graphic Size | 376.991"W x 30"H (includes 2inches of bleed for height) |
| Display Size | 10' Diameter x 28"H |

Finishing

Hem with zipper

| | |
|-------------------|--------|
| Printing Material | Fabric |
|-------------------|--------|

Construction

All aluminum frame construction

Weights - Dimensions

| | |
|---------------------|--------------|
| Shipping Weight | 28lbs |
| Shipping Dimensions | 61"x 15"x 9" |



Graphic Specification

376.991"W x 30"H (includes 2inches of bleed for height)

Graphic Turnaround Time

Standard : 5 business days

Parts List

| | |
|--|---|
|  |  |
| (8) Chain | (36) Spring |
|  | |
| (6) Curved Stabilizer | |
|  | |
| (12) Quarter Circle | |
|  | |
| (1) Nylon Travel Bag | |
|  |  |
| (12) Curved Connector | (3) Eye Hook |
|  |  |
| (9) Large Screw | (8) Hook Loop Lock |
|  |  |
| (1) Screw Tightener | (1) Cable - 9 M |

The box represents 16'x16' booth.

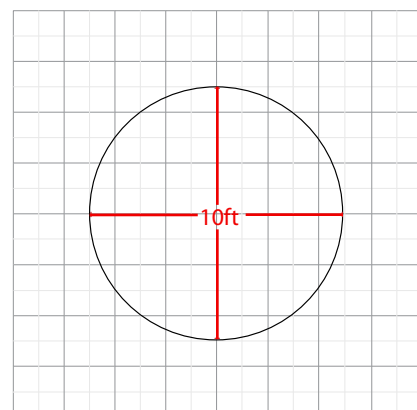

HANGING BANNER 10FT CIRCLE 36IN



Product Features

The Skybox Fabric Hanging Banner is a must have at your next trade show. These extra large hanging banners are produced from high quality fabric and enable you to be seen from practically anywhere at your trade show. Available in round, square, and triangle configurations as well as numerous sizes, there is a Skybox Hanging Banner that would suit almost any situation. This particular model is 10ft wide and 42 inches tall. Includes soft carry bag.

| | |
|--------------|--|
| Graphic Size | 376.991"W x 38"H (includes 2inches of bleed for height) |
| Display Size | 10' Diameter x 36"H |

Finishing

Hem with zipper

| | |
|-------------------|--------|
| Printing Material | Fabric |
|-------------------|--------|

Construction

All aluminum frame construction

Weights - Dimensions

| | |
|---------------------|--------------|
| Shipping Weight | 30 lbs |
| Shipping Dimensions | 61"x 15"x 9" |





Graphic Specification

376.991"W x 38"H (includes 2inches of bleed for height)

Graphic Turnaround Time

Standard : 5 business days

Parts List

| | |
|--|---|
|  |  |
| (8) Chain | (36) Spring |
|  | |
| (6) Curved Stabilizer | |
|  | |
| (12) Quarter Circle | |
|  | |
| (1) Nylon Travel Bag | |
|  |  |
| (12) Curved Connector | (3) Eye Hook |
|  |  |
| (9) Large Screw | (8) Hook Loop Lock |
|  |  |
| (1) Screw Tightener | (1) Cable - 9 M |

The box represents 16'x16' booth.

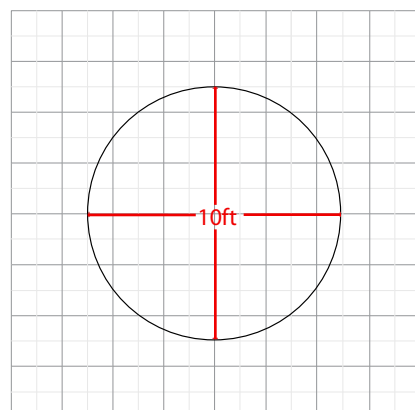

HANGING BANNER 10FT CIRCLE 42IN



Product Features

The Skybox Fabric Hanging Banner is a must have at your next trade show. These extra large hanging banners are produced from high quality fabric and enable you to be seen from practically anywhere at your trade show. Available in round, square, and triangle configurations as well as numerous sizes, there is a Skybox Hanging Banner that would suit almost any situation. This particular model is 10ft wide and 42 inches tall. Includes soft carry bag.

| | |
|--------------|--|
| Graphic Size | 376.991"W x 44"H (includes 2inches of bleed for height) |
| Display Size | 10' Diameter x 42"H |

Finishing

Hem with zipper

| | |
|-------------------|--------|
| Printing Material | Fabric |
|-------------------|--------|

Construction

All aluminum frame construction

Weights - Dimensions

| | |
|---------------------|--------------|
| Shipping Weight | 32 lbs |
| Shipping Dimensions | 61"x 15"x 9" |









Graphic Specification

376.991"W x 44"H (includes 2inches of bleed for height)

Graphic Turnaround Time

Standard : 5 business days

Parts List

| | |
|--|---|
|  |  |
| (8) Chain | (36) Spring |
|  | |
| (6) Curved Stabilizer | |
|  | |
| (12) Quarter Circle | |
|  | |
| (1) Nylon Travel Bag | |
|  |  |
| (12) Curved Connector | (3) Eye Hook |
|  |  |
| (9) Large Screw | (8) Hook Loop Lock |
|  |  |
| (1) Screw Tightener | (1) Cable - 9 M |

The box represents 16'x16' booth.

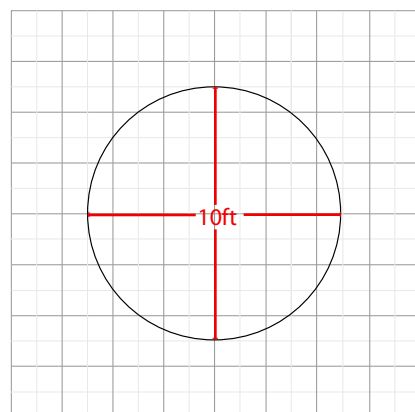

HANGING BANNER 10FT CIRCLE 48IN



Product Features

The Skybox Fabric Hanging Banner is a must have at your next trade show. These extra large hanging banners are produced from high quality fabric and enable you to be seen from practically anywhere at your trade show. Available in round, square, and triangle configurations as well as numerous sizes, there is a Skybox Hanging Banner that would suit almost any situation. This particular model is 10ft wide and 4ft tall. Includes soft carry bag.

Graphic Size 376.991"W x 50"H
(includes 2inches of bleed for height)

Display Size 10' Diameter x 48"H

Finishing

Hem with zipper

Printing Material Fabric

Construction

All aluminum frame construction

Weights - Dimensions

Shipping Weight 34 lbs

Shipping Dimensions 61" x 15" x 9"

Graphic Specification

376.991"W x 50"H (includes 2inches of bleed for height)

Graphic Turnaround Time

Standard : 5 business days

Parts List

| | |
|--|---|
|  |  |
| (8) Chain | (36) Spring |
|  | |
| (6) Curved Stabilizer | |
|  | |
| (12) Quarter Circle | |
|  | |
| (1) Nylon Travel Bag | |
|  |  |
| (12) Curved Connector | (3) Eye Hook |
|  |  |
| (9) Large Screw | (8) Hook Loop Lock |
|  |  |
| (1) Screw Tightener | (1) Cable - 9 M |

The box represents 16'x16' booth.

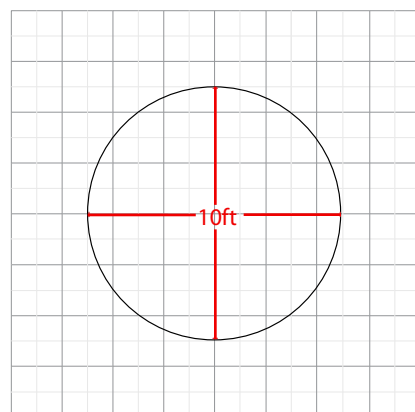

HANGING BANNER 12FT CIRCLE 24IN



Product Features

The Skybox Fabric Hanging Banner is a must have at your next trade show. These extra large hanging banners are produced from high quality fabric and enable you to be seen from practically anywhere at your trade show. Available in round, square, and triangle configurations as well as numerous sizes, there is a Skybox Hanging Banner that would suit almost any situation. This particular model is 12ft wide and 42 inches tall. Includes soft carry bag.

| | |
|--------------|--|
| Graphic Size | 452.389"W x 26"H (includes 2inches of bleed for height) |
|--------------|--|

| | |
|--------------|--------------------|
| Display Size | 12 Diameter x 24"H |
|--------------|--------------------|

Finishing

Hem with zipper

| | |
|-------------------|--------|
| Printing Material | Fabric |
|-------------------|--------|

Construction

All aluminum frame construction

Weights - Dimensions

| | |
|-----------------|--------|
| Shipping Weight | 29 lbs |
|-----------------|--------|

| | |
|---------------------|----------------|
| Shipping Dimensions | 80" x 15" x 9" |
|---------------------|----------------|

Graphic Specification

452.389"W x 26"H (includes 2inches of bleed for height)

Graphic Turnaround Time

Standard : 5 business days

Parts List



(8) Chain



(36) Spring



(6) Curved Stabilizer



(12) Quarter Circle



(1) Nylon Travel Bag



(12) Curved Connector



(3) Eye Hook



(9) Large Screw



(8) Hook Loop Lock



(1) Screw Tightener



(1) Cable - 9 M

The box represents 16'x16' booth.

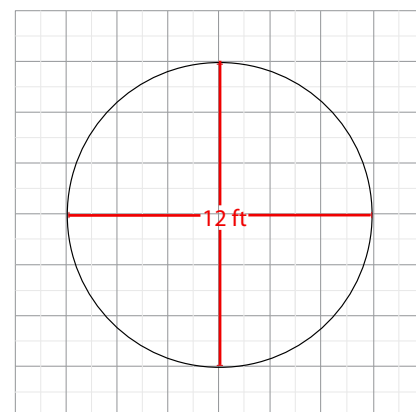

HANGING BANNER 12FT CIRCLE 32IN



Product Features

The Skybox Fabric Hanging Banner is a must have at your next trade show. These extra large hanging banners are produced from high quality fabric and enable you to be seen from practically anywhere at your trade show. Available in round, square, and triangle configurations as well as numerous sizes, there is a Skybox Hanging Banner that would suit almost any situation. This particular model is 12ft wide and 42 inches tall. Includes soft carry bag.

| | |
|--------------|--|
| Graphic Size | 452.389"W x 34"H (includes 2inches of bleed for height) |
|--------------|--|

| | |
|--------------|--------------------|
| Display Size | 12 Diameter x 32"H |
|--------------|--------------------|

Finishing

Hem with zipper

| | |
|-------------------|--------|
| Printing Material | Fabric |
|-------------------|--------|

Construction

All aluminum frame construction

Weights - Dimensions

| | |
|-----------------|--------|
| Shipping Weight | 31 lbs |
|-----------------|--------|

| | |
|---------------------|----------------|
| Shipping Dimensions | 80" x 15" x 9" |
|---------------------|----------------|

Graphic Specification

452.389"W x 34"H (includes 2inches of bleed for height)

Graphic Turnaround Time

Standard : 5 business days

Parts List

| | |
|--|---|
|  |  |
| (8) Chain | (36) Spring |
|  | |
| (6) Curved Stabilizer | |
|  | |
| (12) Quarter Circle | |
|  | |
| (1) Nylon Travel Bag | |
|  |  |
| (12) Curved Connector | (3) Eye Hook |
|  |  |
| (9) Large Screw | (8) Hook Loop Lock |
|  |  |
| (1) Screw Tightener | (1) Cable - 9 M |

The box represents 16'x16' booth.

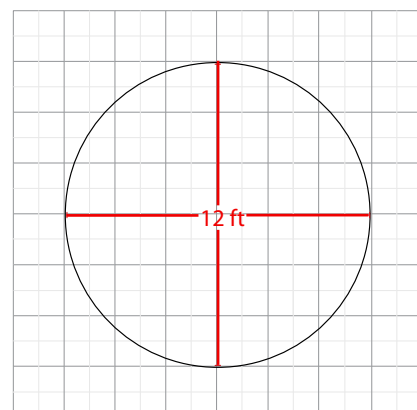

HANGING BANNER 12FT CIRCLE 36IN



Product Features

The Skybox Fabric Hanging Banner is a must have at your next trade show. These extra large hanging banners are produced from high quality fabric and enable you to be seen from practically anywhere at your trade show. Available in round, square, and triangle configurations as well as numerous sizes, there is a Skybox Hanging Banner that would suit almost any situation. This particular model is 12ft wide and 42 inches tall. Includes soft carry bag.

| | |
|--------------|--|
| Graphic Size | 452.389"W x 38"H (includes 2inches of bleed for height) |
|--------------|--|

| | |
|--------------|--------------------|
| Display Size | 12 Diameter x 36"H |
|--------------|--------------------|

Finishing

Hem with zipper

| | |
|-------------------|--------|
| Printing Material | Fabric |
|-------------------|--------|

Construction

All aluminum frame construction

Weights - Dimensions

| | |
|-----------------|--------|
| Shipping Weight | 33 lbs |
|-----------------|--------|

| | |
|---------------------|----------------|
| Shipping Dimensions | 80" x 15" x 9" |
|---------------------|----------------|

Graphic Specification

452.389"W x 36"H (includes 2inches of bleed for height)

Graphic Turnaround Time

Standard : 5 business days

Parts List

| | |
|--|---|
|  |  |
| (8) Chain | (36) Spring |
|  | |
| (6) Curved Stabilizer | |
|  | |
| (12) Quarter Circle | |
|  | |
| (1) Nylon Travel Bag | |
|  |  |
| (12) Curved Connector | (3) Eye Hook |
|  |  |
| (9) Large Screw | (8) Hook Loop Lock |
|  |  |
| (1) Screw Tightener | (1) Cable - 9 M |

The box represents 16'x16' booth.

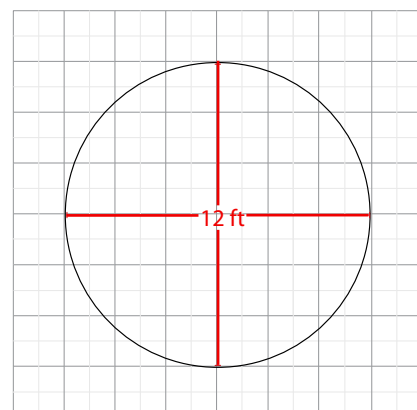

HANGING BANNER 12FT CIRCLE 42IN

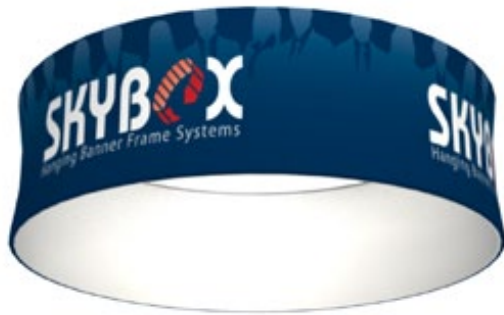

Product Features

The Skybox Fabric Hanging Banner is a must have at your next trade show. These extra large hanging banners are produced from high quality fabric and enable you to be seen from practically anywhere at your trade show. Available in round, square, and triangle configurations as well as numerous sizes, there is a Skybox Hanging Banner that would suit almost any situation. This particular model is 12ft wide and 42 inches tall. Includes soft carry bag.

| | |
|--------------|--|
| Graphic Size | 452.389"W x 44"H (includes 2inches of bleed for height) |
|--------------|--|

| | |
|--------------|--------------------|
| Display Size | 12 Diameter x 42"H |
|--------------|--------------------|

Finishing

Hem with zipper

| | |
|-------------------|--------|
| Printing Material | Fabric |
|-------------------|--------|

Construction

All aluminum frame construction

Weights - Dimensions

| | |
|-----------------|--------|
| Shipping Weight | 35 lbs |
|-----------------|--------|

| | |
|---------------------|----------------|
| Shipping Dimensions | 80" x 15" x 9" |
|---------------------|----------------|

Graphic Specification

452.389"W x 44"H (includes 2inches of bleed for height)

Graphic Turnaround Time

Standard : 5 business days

Parts List



(8) Chain



(36) Spring



(6) Curved Stabilizer



(12) Quarter Circle



(1) Nylon Travel Bag



(12) Curved Connector



(3) Eye Hook



(9) Large Screw



(8) Hook Loop Lock



(1) Screw Tightener



(1) Cable - 9 M

The box represents 16'x16' booth.

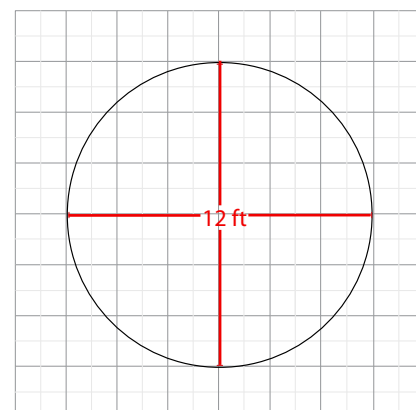

HANGING BANNER 12FT CIRCLE 48IN



Product Features

The Skybox Fabric Hanging Banner is a must have at your next trade show. These extra large hanging banners are produced from high quality fabric and enable you to be seen from practically anywhere at your trade show. Available in round, square, and triangle configurations as well as numerous sizes, there is a Skybox Hanging Banner that would suit almost any situation. This particular model is 12ft wide and 4ft tall. Includes soft carry bag.

| | |
|--------------|--|
| Graphic Size | 452.389"W x 50"H (includes 2inches of bleed for height) |
|--------------|--|

| | |
|--------------|--------------------|
| Display Size | 12 Diameter x 48"H |
|--------------|--------------------|

Finishing

Hem with zipper

| | |
|-------------------|--------|
| Printing Material | Fabric |
|-------------------|--------|

Construction

All aluminum frame construction

Weights - Dimensions

| | |
|-----------------|--------|
| Shipping Weight | 37 lbs |
|-----------------|--------|

| | |
|---------------------|----------------|
| Shipping Dimensions | 80" x 15" x 9" |
|---------------------|----------------|



Graphic Specification

452.389"W x 50"H (includes 2inches of bleed for height)

Graphic Turnaround Time

Standard : 5 business days

Parts List

| | |
|--|---|
|  |  |
| (8) Chain | (36) Spring |
|  | |
| (6) Curved Stabilizer | |
|  | |
| (12) Quarter Circle | |
|  | |
| (1) Nylon Travel Bag | |
|  |  |
| (12) Curved Connector | (3) Eye Hook |
|  |  |
| (9) Large Screw | (8) Hook Loop Lock |
|  |  |
| (1) Screw Tightener | (1) Cable - 10 M |

The box represents 16'x16' booth.

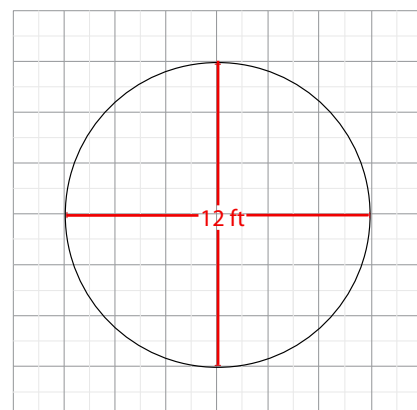

HANGING BANNER 15FT CIRCLE 24IN



Product Features

The Skybox Fabric Hanging Banner is a must have at your next trade show. These extra large hanging banners are produced from high quality fabric and enable you to be seen from practically anywhere at your trade show. Available in round, square, and triangle configurations as well as numerous sizes, there is a Skybox Hanging Banner that would suit almost any situation. This particular model is 15ft wide and 42inches tall. Includes soft carry bag.

| | |
|--------------|--|
| Graphic Size | 565.486"W x 26"H (includes 2inches of bleed for height) |
|--------------|--|

| | |
|--------------|---------------------|
| Display Size | 15' Diameter x 24"H |
|--------------|---------------------|

Finishing

Hem with zipper

| | |
|-------------------|--------|
| Printing Material | Fabric |
|-------------------|--------|

Construction

All aluminum frame construction

Weights - Dimensions

| | |
|-----------------|--------|
| Shipping Weight | 36 lbs |
|-----------------|--------|

| | |
|---------------------|----------------|
| Shipping Dimensions | 72" x 17" x 9" |
|---------------------|----------------|

Graphic Specification

565.486"W x 26"H (includes 2inches of bleed for height)

Graphic Turnaround Time

Standard : 5 business days

Parts List

| | |
|--|---|
|  |  |
| (10) Chain | (48) Spring |
|  | |
| (8) Curved Stabilizer | |
|  | |
| (16) Quarter Circle | |
|  | |
| (1) Nylon Travel Bag | |
|  |  |
| (16) Curved Connector | (4) Eye Hook |
|  |  |
| (12) Large Screw | (10) Hook Loop Lock |
|  |  |
| (1) Screw Tightener | (1) Cable - 13.8 M |

The box represents 16'x16' booth.

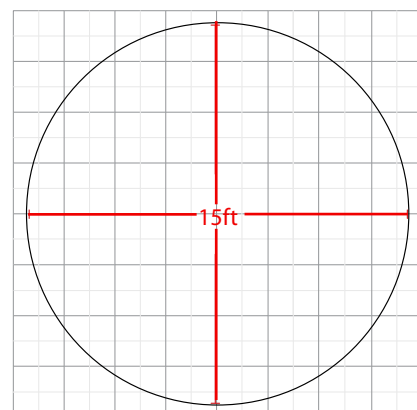

HANGING BANNER 15FT CIRCLE 32IN



Product Features

The Skybox Fabric Hanging Banner is a must have at your next trade show. These extra large hanging banners are produced from high quality fabric and enable you to be seen from practically anywhere at your trade show. Available in round, square, and triangle configurations as well as numerous sizes, there is a Skybox Hanging Banner that would suit almost any situation. This particular model is 15ft wide and 42inches tall. Includes soft carry bag.

| | |
|--------------|--|
| Graphic Size | 565.486"W x 34"H (includes 2inches of bleed for height) |
| Display Size | 15' Diameter x 32"H |

Finishing

Hem with zipper

| | |
|-------------------|--------|
| Printing Material | Fabric |
|-------------------|--------|

Construction

All aluminum frame construction

Weights - Dimensions

| | |
|---------------------|----------------|
| Shipping Weight | 38 lbs |
| Shipping Dimensions | 72" x 17" x 9" |

Graphic Specification

565.486"W x 34"H (includes 2inches of bleed for height)

Graphic Turnaround Time

Standard : 5 business days

Parts List

| | |
|--|---|
|  |  |
| (10) Chain | (48) Spring |
|  | |
| (8) Curved Stabilizer | |
|  | |
| (16) Quarter Circle | |
|  | |
| (1) Nylon Travel Bag | |
|  |  |
| (16) Curved Connector | (4) Eye Hook |
|  |  |
| (12) Large Screw | (10) Hook Loop Lock |
|  |  |
| (1) Screw Tightener | (1) Cable - 13.8 M |

The box represents 16'x16' booth.

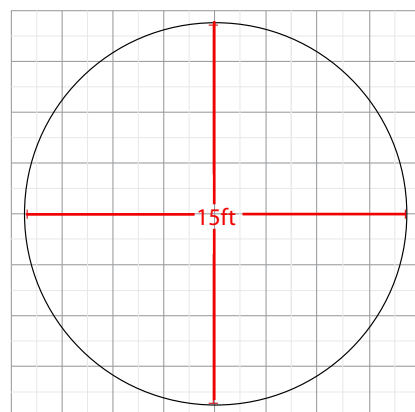

HANGING BANNER 15FT CIRCLE 36IN



Product Features

The Skybox Fabric Hanging Banner is a must have at your next trade show. These extra large hanging banners are produced from high quality fabric and enable you to be seen from practically anywhere at your trade show. Available in round, square, and triangle configurations as well as numerous sizes, there is a Skybox Hanging Banner that would suit almost any situation. This particular model is 15ft wide and 42inches tall. Includes soft carry bag.

| | |
|--------------|--|
| Graphic Size | 565.486"W x 38"H (includes 2inches of bleed for height) |
| Display Size | 15' Diameter x 36"H |

Finishing

Hem with zipper

| | |
|-------------------|--------|
| Printing Material | Fabric |
|-------------------|--------|

Construction

All aluminum frame construction

Weights - Dimensions

| | |
|---------------------|----------------|
| Shipping Weight | 40 lbs |
| Shipping Dimensions | 72" x 17" x 9" |

Graphic Specification

565.486"W x 38"H (includes 2inches of bleed for height)

Graphic Turnaround Time

Standard : 5 business days

Parts List

| | |
|--|---|
|  |  |
| (10) Chain | (48) Spring |
|  | |
| (8) Curved Stabilizer | |
|  | |
| (16) Quarter Circle | |
|  | |
| (1) Nylon Travel Bag | |
|  |  |
| (16) Curved Connector | (4) Eye Hook |
|  |  |
| (12) Large Screw | (10) Hook Loop Lock |
|  |  |
| (1) Screw Tightener | (1) Cable - 13.8 M |

The box represents 16'x16' booth.

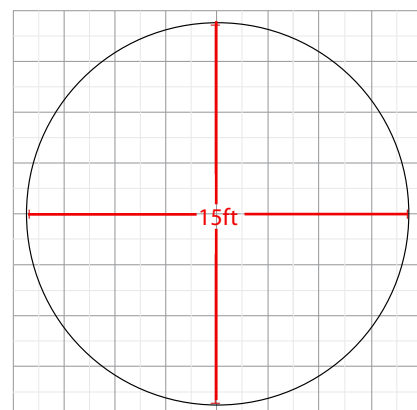

HANGING BANNER 15FT CIRCLE 42IN



Product Features

The Skybox Fabric Hanging Banner is a must have at your next trade show. These extra large hanging banners are produced from high quality fabric and enable you to be seen from practically anywhere at your trade show. Available in round, square, and triangle configurations as well as numerous sizes, there is a Skybox Hanging Banner that would suit almost any situation. This particular model is 15ft wide and 42inches tall. Includes soft carry bag.

| | |
|--------------|--|
| Graphic Size | 565.486"W x 44"H (includes 2inches of bleed for height) |
|--------------|--|

| | |
|--------------|---------------------|
| Display Size | 15' Diameter x 42"H |
|--------------|---------------------|

Finishing

Hem with zipper

| | |
|-------------------|--------|
| Printing Material | Fabric |
|-------------------|--------|

Construction

All aluminum frame construction

Weights - Dimensions

| | |
|-----------------|--------|
| Shipping Weight | 42 lbs |
|-----------------|--------|

| | |
|---------------------|----------------|
| Shipping Dimensions | 72" x 17" x 9" |
|---------------------|----------------|

Graphic Specification

565.486"W x 44"H (includes 2inches of bleed for height)

Graphic Turnaround Time

Standard : 5 business days

Parts List

| | |
|--|---|
|  |  |
| (10) Chain | (48) Spring |
|  | |
| (8) Curved Stabilizer | |
|  | |
| (16) Quarter Circle | |
|  | |
| (1) Nylon Travel Bag | |
|  |  |
| (16) Curved Connector | (4) Eye Hook |
|  |  |
| (12) Large Screw | (10) Hook Loop Lock |
|  |  |
| (1) Screw Tightener | (1) Cable - 13.8 M |

The box represents 16'x16' booth.

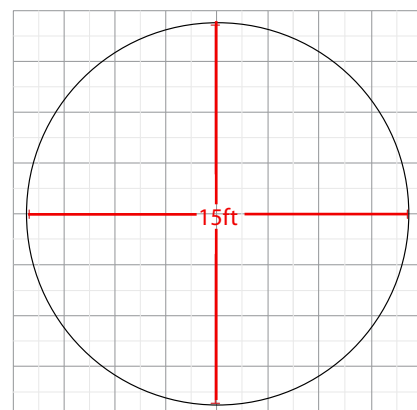

HANGING BANNER 15FT CIRCLE 48IN



Product Features

The Skybox Fabric Hanging Banner is a must have at your next trade show. These extra large hanging banners are produced from high quality fabric and enable you to be seen from practically anywhere at your trade show. Available in round, square, and triangle configurations as well as numerous sizes, there is a Skybox Hanging Banner that would suit almost any situation. This particular model is 15ft wide and 4ft tall. Includes soft carry bag.

| | |
|--------------|--|
| Graphic Size | 565.486"W x 50"H (includes 2inches of bleed for height) |
|--------------|--|

| | |
|--------------|---------------------|
| Display Size | 15' Diameter x 48"H |
|--------------|---------------------|

Finishing

Hem with zipper

| | |
|-------------------|--------|
| Printing Material | Fabric |
|-------------------|--------|

Construction

All aluminum frame construction

Weights - Dimensions

| | |
|-----------------|--------|
| Shipping Weight | 44 lbs |
|-----------------|--------|

| | |
|---------------------|----------------|
| Shipping Dimensions | 72" x 17" x 9" |
|---------------------|----------------|

Graphic Specification

565.486"W x 50"H (includes 2inches of bleed for height)

Graphic Turnaround Time

Standard : 5 business days

Parts List

| | |
|--|---|
|  |  |
| (10) Chain | (48) Spring |
|  | |
| (16) Curved Stabilizer | |
|  | |
| (16) Quarter Circle | |
|  | |
| (1) Nylon Travel Bag | |
|  |  |
| (16) Curved Connector | (4) Eye Hook |
|  |  |
| (12) Large Screw | (10) Hook Loop Lock |
|  |  |
| (1) Screw Tightener | (1) Cable - 13.8 M |

The box represents 16'x16' booth.

